

# ALCAMO



Fabryka Frontów Meblowych



grubość szuflady	18 mm
------------------	-------

grubość front	18 mm
---------------	-------

	stoje pionowo *	stoje poziomo *
max. wysokość	2500	1243
max. szerokość	1243	2500

\* nie dotyczy folii poprzecznych

wykończenie :

folie jednobarwne, drewnopodobne i matowe	TAK
folie wysokopółgłaskowe	---
lakier matowy	TAK
możliwość patynowania (folia, lakier)	TAK

## szuflady

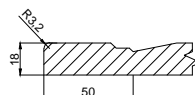
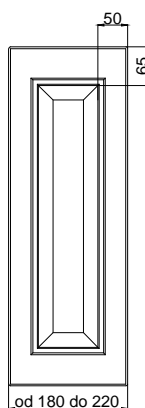
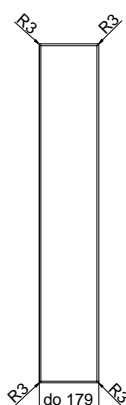
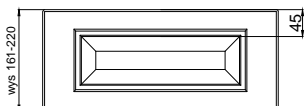
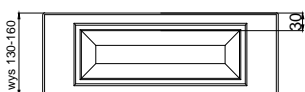
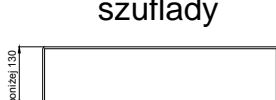

## front

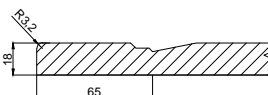
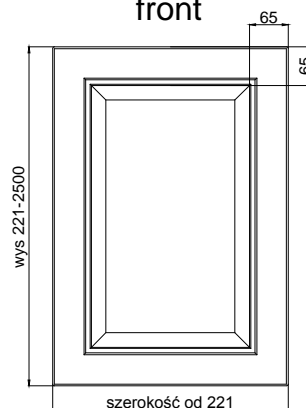

## witryna

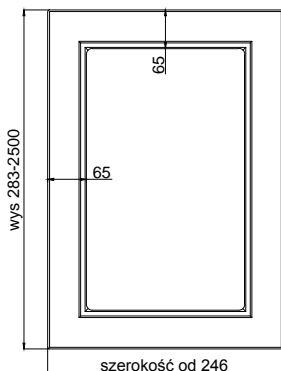

## szpros 4 okna

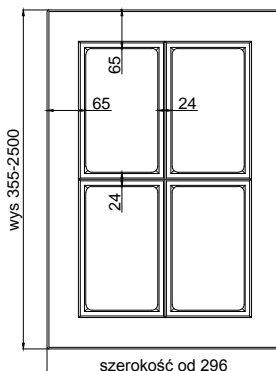

## szpros 6 okien

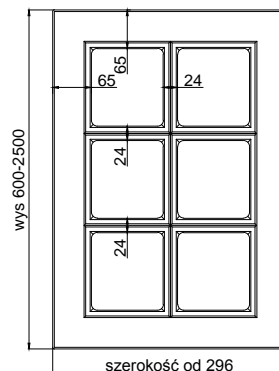

## DODATKOWE MOŻLIWOŚCI WYKONANIA

### FRONTY GIĘTE

R 240 ZEW	TAK
R 240 WEW, "S"	---
R 450 ZEW, R 450 WEW	---
R 1000 ZEW, R 1000 WEW	---

### POZOSTAŁE KSZTAŁTY ELEMENTÓW

ŁUK KOMPLET	TAK
DRZWI KOMPLET	---
DRZWI DWA ŁUKI	---
LISTWA POD WINO	TAK

WYCIĘCIE NA PALEC	TAK
WITRYNA KOMPLET	---
WITRYNA DWA ŁUKI	---
WITRYNA SZPROS	TAK